

HINGE

บานพับ

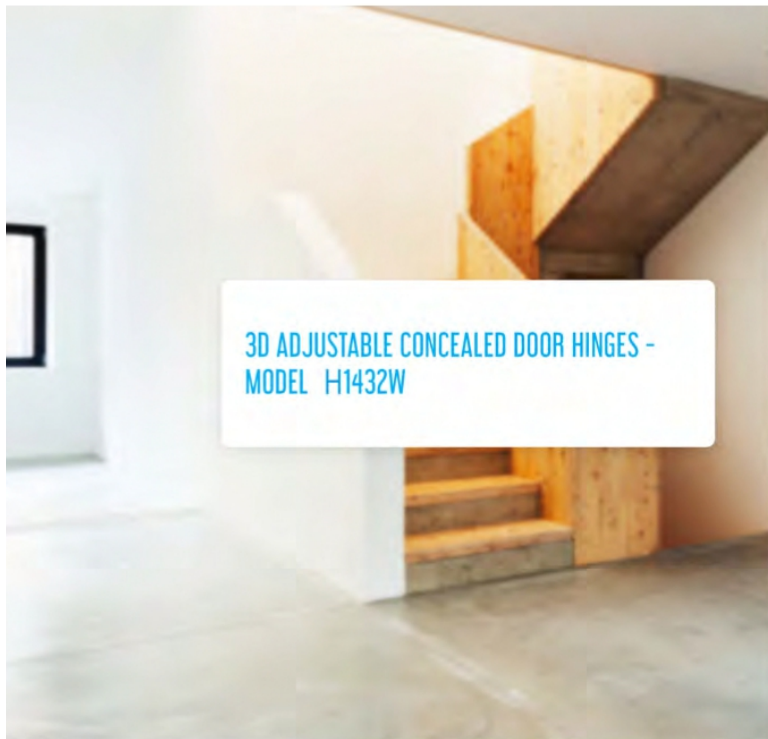

3D ADJUSTABLE CONCEALED DOOR HINGES -
MODEL H1432W



H1432W

The new hinge model 1432W has an increased room between the two hinges levers, thus allowing **claddings up to 8mm** applied both sides. The great load capacity of 160kg, puts few limits to your creativity! Glass, wood, even marble claddings will enrich your ambiances.

Height: 230 mm

Depth: 32 mm

Minimum door thickness: 38 mm

Utilization: Residential, Commercial, Office, Entrance door, Marine use

Width: 32 mm

Suitable for doors: Wood, Aluminium, Steel

Fire resistance: n.d.



Load capacity 2 hinges: 160 kg

Load capacity 3 hinges: 195 kg

For special door sizes and use of door closer devices, please read carefully the technical guidelines.

HINGE

บานพับ



1432W

mm.230x32

Available in 12 finishes.

Invisible adjustable hinges for doors

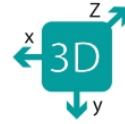

MAIN FEATURES:

- Engineered for heavy doors: load capacity up to 195 kg
- Suitable for claddings installations: up to 8 mm both on frame and door side
- Minimum door thickness 38 mm
- Simmetric and only 32 mm deep

MAINTENANCEFREE

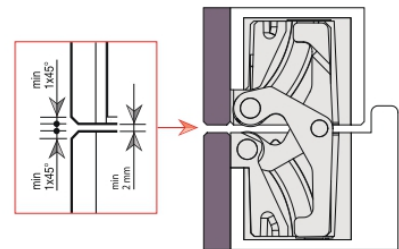
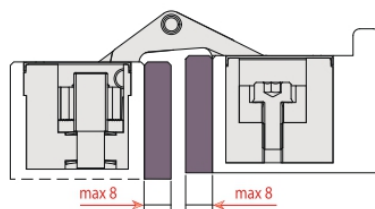
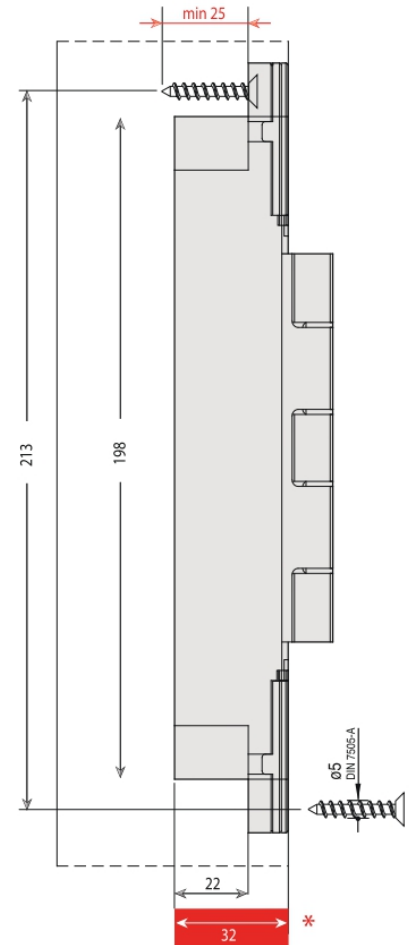
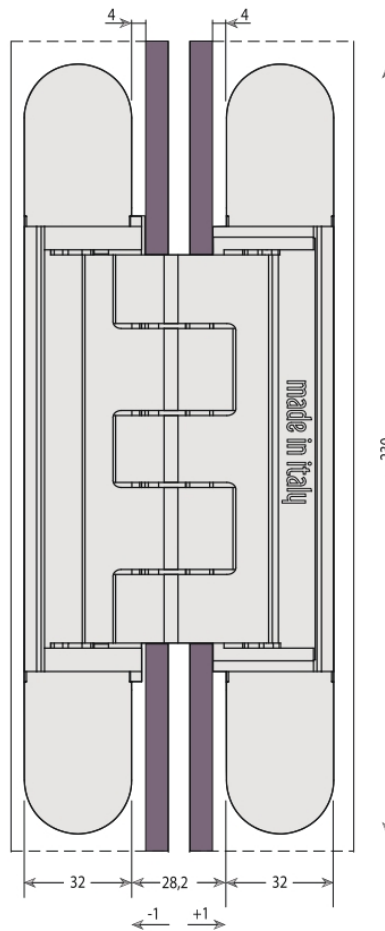

* Small drilling depth

HINGE

บานพับ

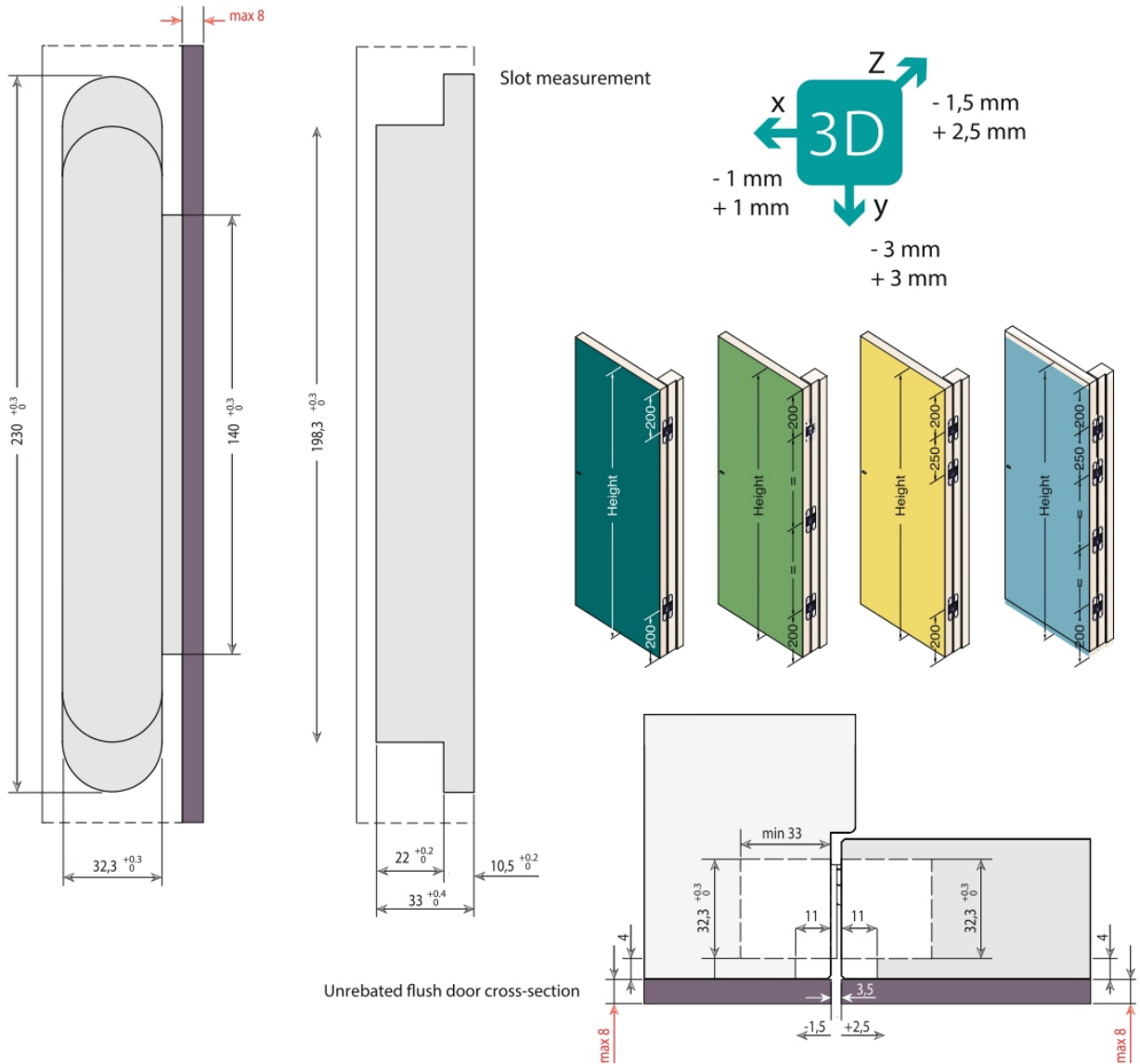

2 HINGES LOAD CAPACITY CHART

DOOR HEIGHT (mm)	2200	160	160	160	157	133	119	108
2100	160	160	160	144	125	112	103	
2000	160	160	160	133	117	107	99	
1900	160	160	145	124	111	102	95	
		700	800	900	1000	1100	1200	1300
		DOOR WIDTH (mm)						

3 HINGES LOAD CAPACITY CHART

DOOR HEIGHT (mm)	3000	195	195	195	195	195	195	195	195
2900	195	195	195	195	195	195	195	195	
2800	195	195	195	195	195	195	195	183	
2700	195	195	195	195	195	195	195	170	
2600	195	195	195	195	195	195	185	160	
2500	195	195	195	195	195	195	171	150	
2400	195	195	195	195	195	187	160	142	
2300	195	195	195	195	172	149	134		
2200	195	195	195	191	160	140	127		
2100	195	195	195	174	149	132	121		
2000	195	195	195	160	139	125	116		
		700	800	900	1000	1100	1200	1300	
		DOOR WIDTH (mm)							

4 HINGES SUGGESTED

For special door sizes and use of door closer devices, please see the technical guidelines

HINGE

บานพับ



Adjustment guidelines H1432W | H929

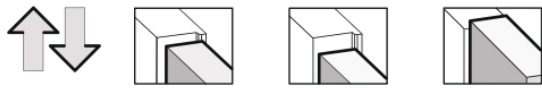

Vertical adjustment

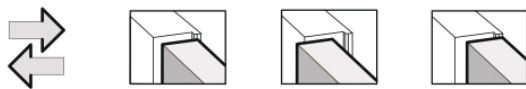
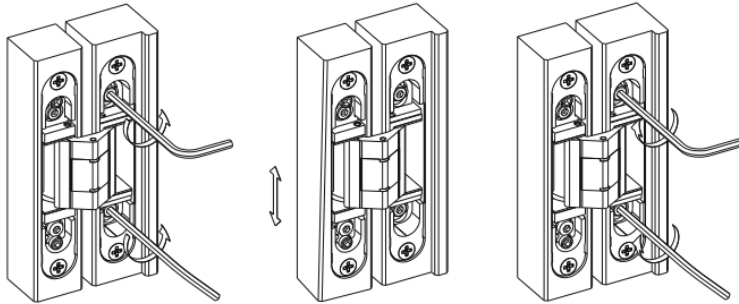
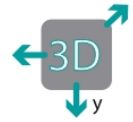

Horizontal adjustment

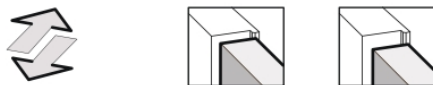
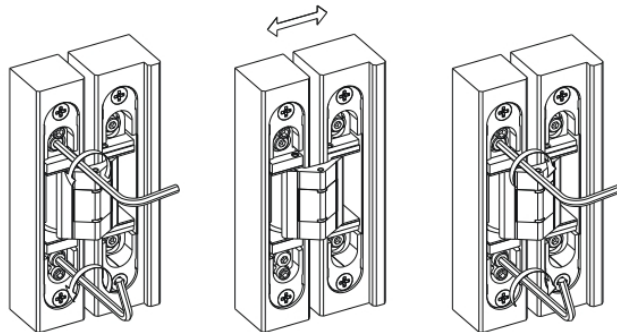
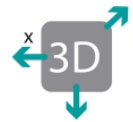

Depth adjustment

