

# HINGE

บานพับ



3D ADJUSTABLE CONCEALED DOOR HINGES -  
MODEL H1230

## S.T.A.R.S. H1230

THE REVERSIBLE HINGE FOR DOORS WITH THICKNESS FROM 35 TO 45MM

**3D concealed hinges:** with a gap between the two wings of 23mm, 1230s is the ideal solution for reversible doors or to go around skirting boards or trims or claddings.

**Height:** 130 mm

**Depth:** 21 mm

**Minimum door thickness:** 35 mm

**Utilization:** Residential, Commercial, Office

**Width:** 30 mm

**Suitable for doors:** Wood, Aluminium, Steel

**Fire resistance:** E130



**Load capacity 2 hinges:** 55 kg

**Load capacity 3 hinges:** 70 kg

For special door sizes and use of door closer devices, please read carefully the technical guidelines.

# HINGE

บานพับ



**H1230**  
mm.130x30

Invisible adjustable hinges for doors

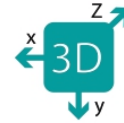

Available in 11 finishes

MAINTENANCE**FREE**

**MAIN FEATURES:**

- Manufactured in zamak in 11 different finishes
- Suitable for doors of 35 mm min. thickness
- Big reversibility range: central for doors from 35 to 45 mm thick
- Suitable in case of baseboard or claddings till 15,5 mm
- Total length 130 mm
- Depth 21 mm only
- 3D adjusting system S.T.A.R.S.
- Load capacity up to 70 kg
- Easy installation and slot symmetry
- Revised in aesthetics and operation: now more elegant and resistant to oxidation due to the new external case in zincked zamak. Joint evolved for better performance: smoother movement, extremely precise, durable and now certified for doors up to 1000 mm wide

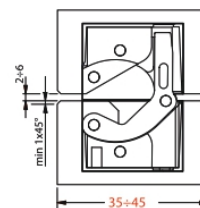
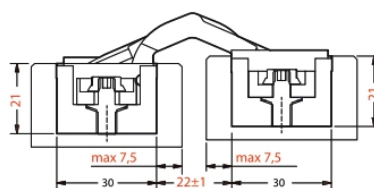
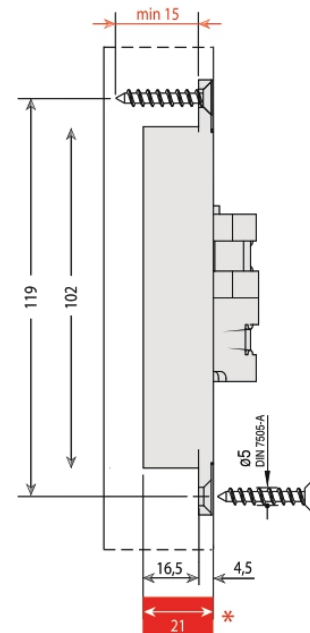
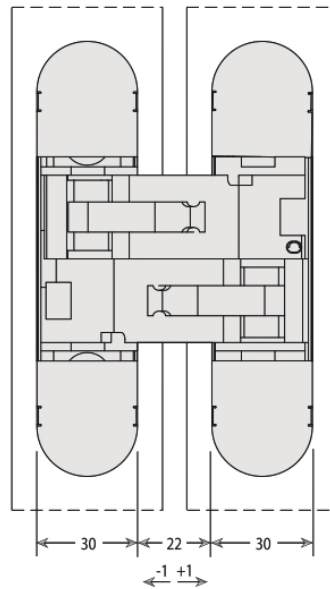
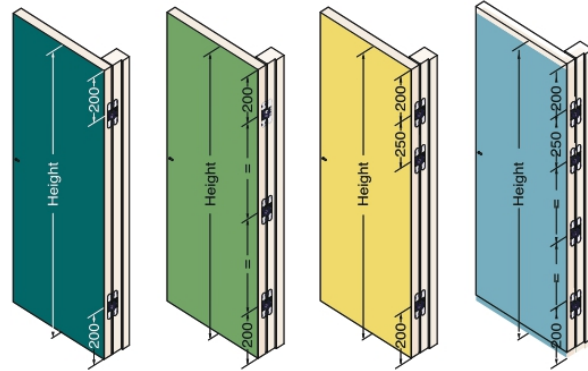

\* Small drilling depth

# HINGE

บานพับ

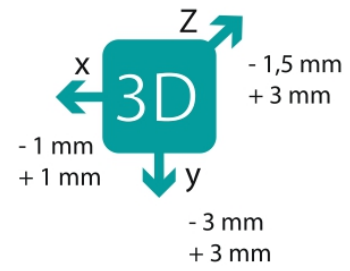
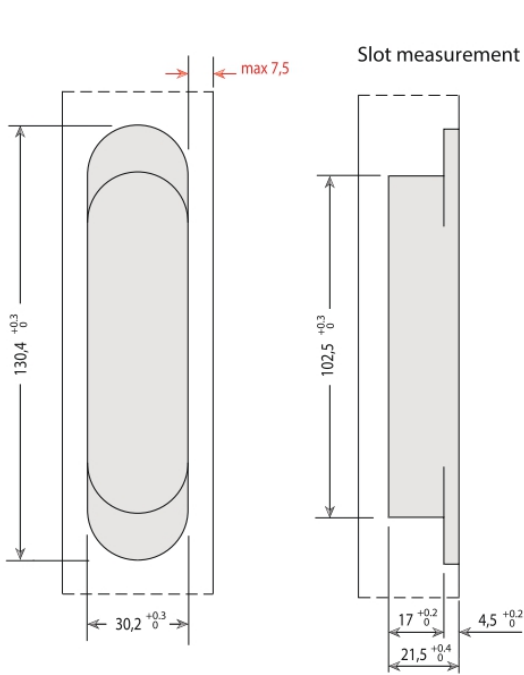

**REVERSIBILITY**  
Reversible for doors from 35 mm to 45 mm thick

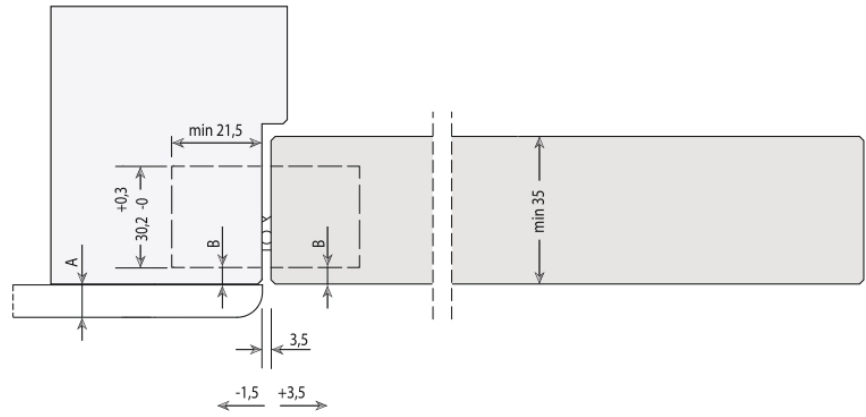
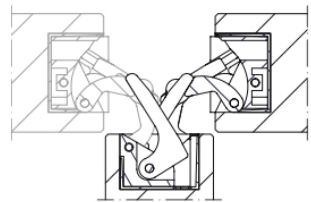

Door cross-section

A	B
15,5	2,5
14,5	3
13,5	3,5
12	4
10	4,5
8	5

**2 HINGES LOAD CAPACITY CHART**

DOOR HEIGHT (mm)	DOOR WIDTH (mm)						
	700	800	900	1000	1100	1200	1300
2200	55	55	55	54	46	41	37
2100	55	55	55	50	43	39	36
2000	55	55	55	46	41	37	34
1900	55	55	50	43	38	35	33

**3 HINGES LOAD CAPACITY CHART**

DOOR HEIGHT (mm)	DOOR WIDTH (mm)							4 HINGES SUGGESTED
	700	800	900	1000	1100	1200	1300	
3000	70	70	70	70	70	70	70	4 HINGES SUGGESTED
2900	70	70	70	70	70	70	70	
2800	70	70	70	70	70	70	65	
2700	70	70	70	70	70	70	61	
2600	70	70	70	70	70	70	66	
2500	70	70	70	70	70	70	61	
2400	70	70	70	70	67	57	51	
2300	70	70	70	70	62	54	48	
2200	70	70	70	68	57	50	46	
2100	70	70	70	62	53	47	44	
2000	70	70	70	57	50	45	42	

For special door sizes and use of door closer devices, please see the technical guidelines

# HINGE

บานพับ



## Adjustment guidelines H1131 | H1230

Invisible adjustable hinges for doors

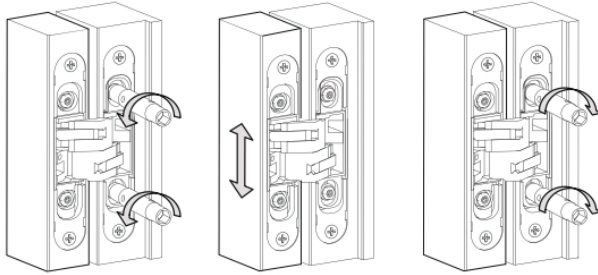
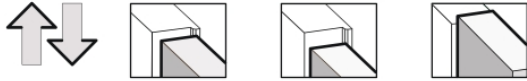

Vertical adjustment

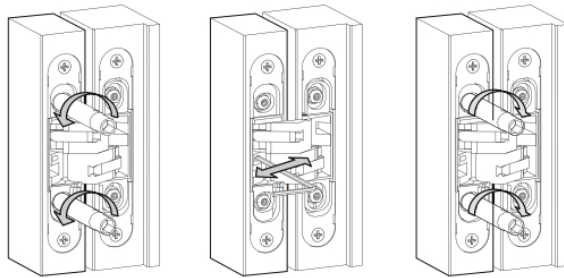
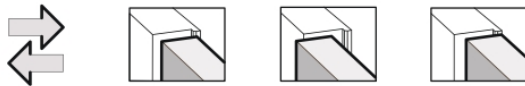

Horizontal adjustment

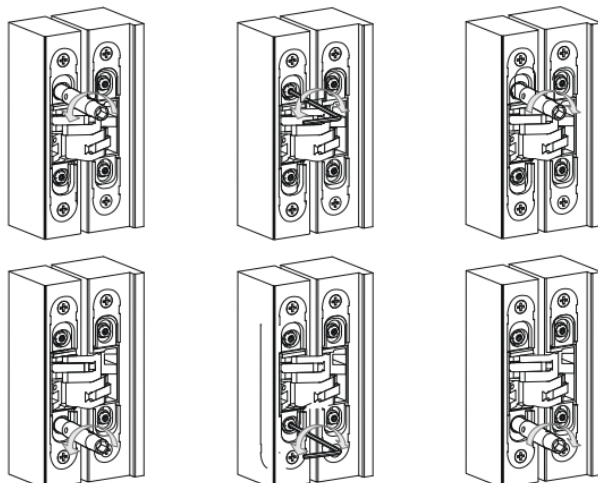
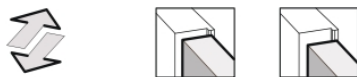

Depth adjustment

