



Model N0 : AL-283 PC , AL-283 SBN

Application : Wooden Door

Main Material : Zinc Alloy

Finish : Polished Chrome (PC) 
Satin Black Nickel (SBN) 

Function : Entry / Bathroom

Door Thickness : 35-50 mm.



Magnetic Mortise Lock

Material of latch & bolt: zinc alloy
Material of forend: 201 Stainless Steel
Backset: 55mm
Center distance: 72mm

Finishes: ● Satin Nickel
● Satin Black Nickel

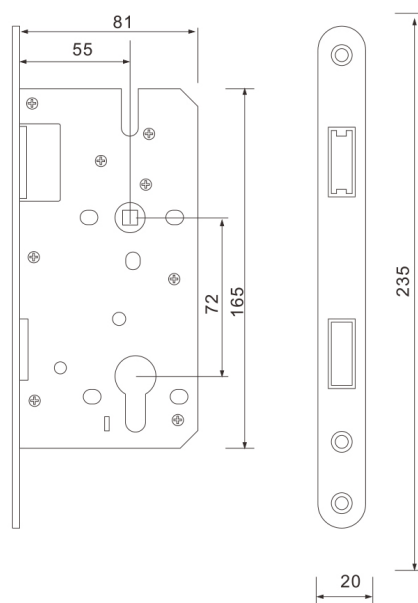

70mm single open cylinder

Materials: Zinc Cover Brass, Brass

Function: Entry, Privacy

Doors: Wooden Doors, Metal Doors

Standard Fittings: A Cylinder, 4 keys, Cylinder Screws

Finishes: ● Satin Nickel ● Matt Black

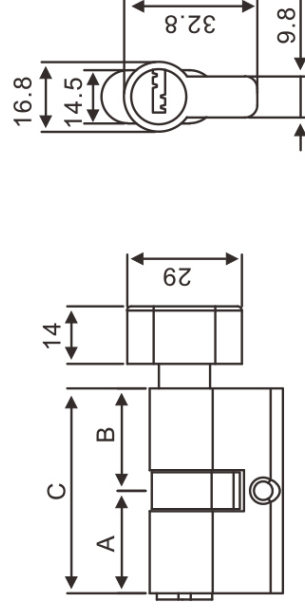

(C=70mm, A=B=35mm)

Magnetic Mortise Lock

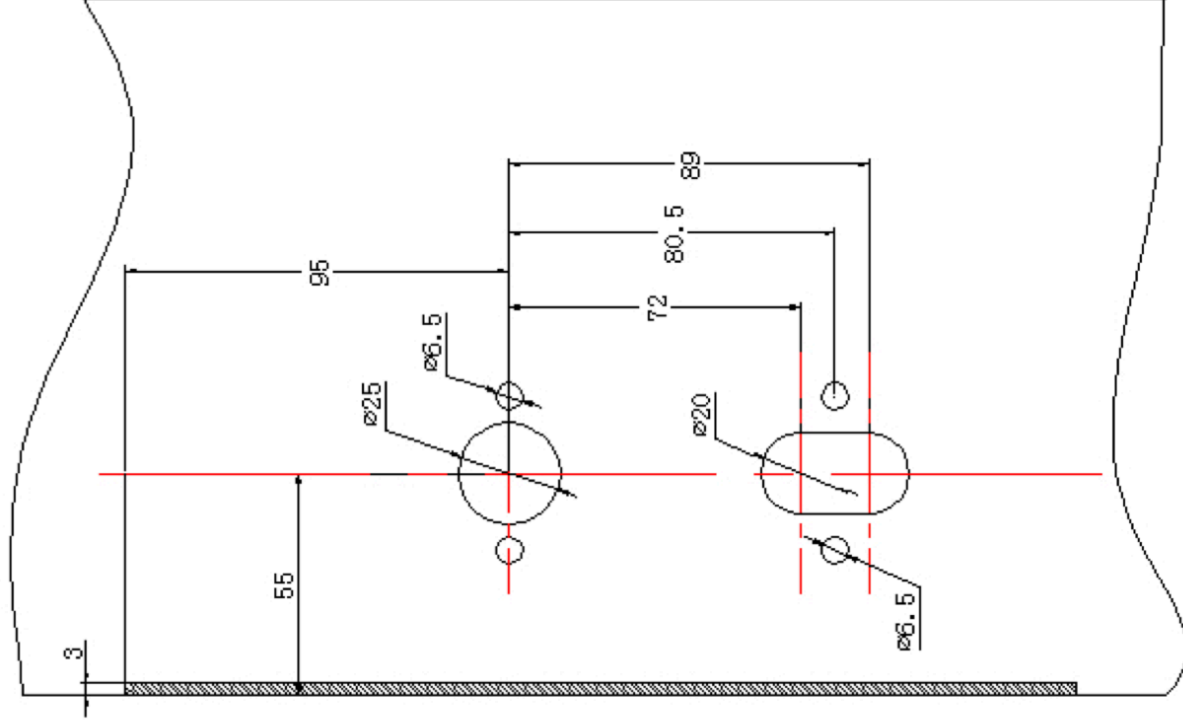
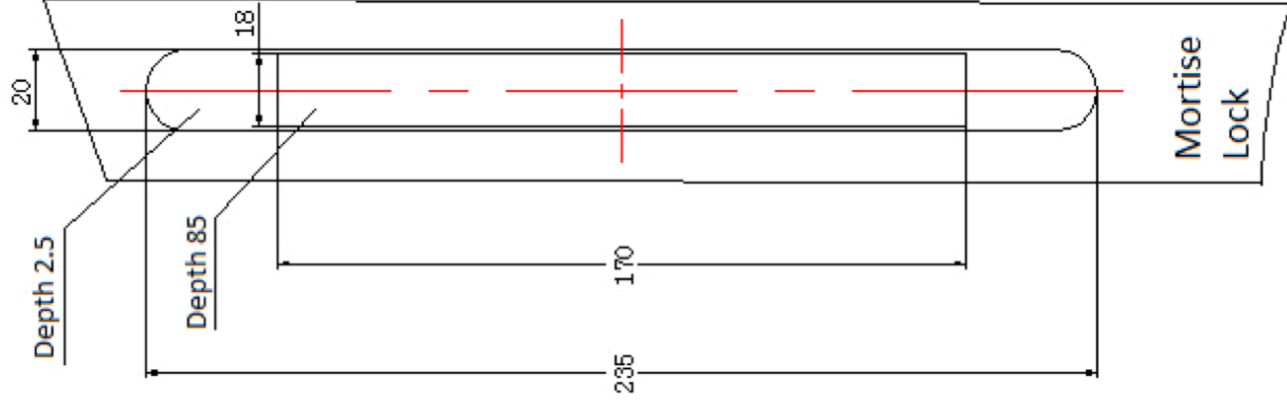
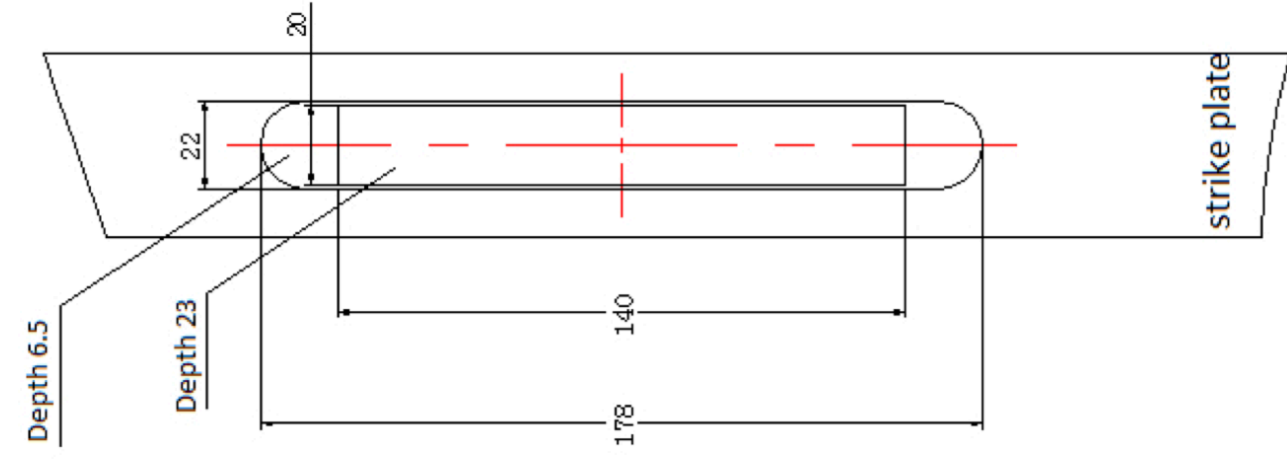



Matt Satin Nickel



Polished Chrome



Satin Black Nickel