

Invisible adjustable hinges

3D adjusting system S.T.A.R.S.





3D ADJUSTABLE CONCEALED DOOR HINGES -
MODEL H1432W



H1432W

The new hinge model 1432W has an increased room between the two hinges levers, thus allowing **claddings up to 8mm** applied both sides. The great load capacity of 160kg, puts few limits to your creativity! Glass, wood, even marble claddings will enrich your ambiances.

Height: 230 mm

Depth: 32 mm

Minimum door thickness: 38 mm

Utilization: Residential, Commercial, Office, Entrance door, Marine use

Width: 32 mm

Suitable for doors: Wood, Alluminium, Steel

Fire resistance: n.d.



Load capacity 2 hinges: 160 kg

Load capacity 3 hinges: 195 kg

For special door sizes and use of door closer devices, please read carefully the technical guidelines.

HINGE

บานพับ



1432W

mm.230x32

Available in 12 finishes.

Invisible adjustable hinges for doors

MAIN FEATURES:

- Engineered for heavy doors: load capacity up to 195 kg
- Suitable for claddings installations: up to 8 mm both on frame and door side
- Minimum door thickness 38 mm
- Simmetric and only 32 mm deep

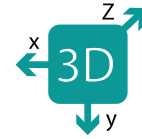

MAINTENANCEFREE

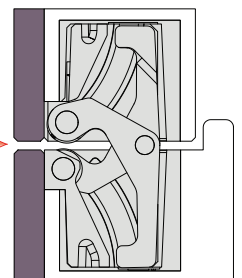
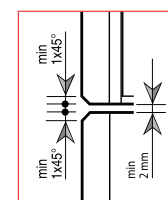
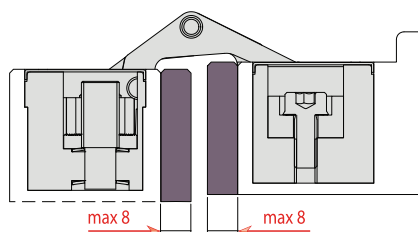
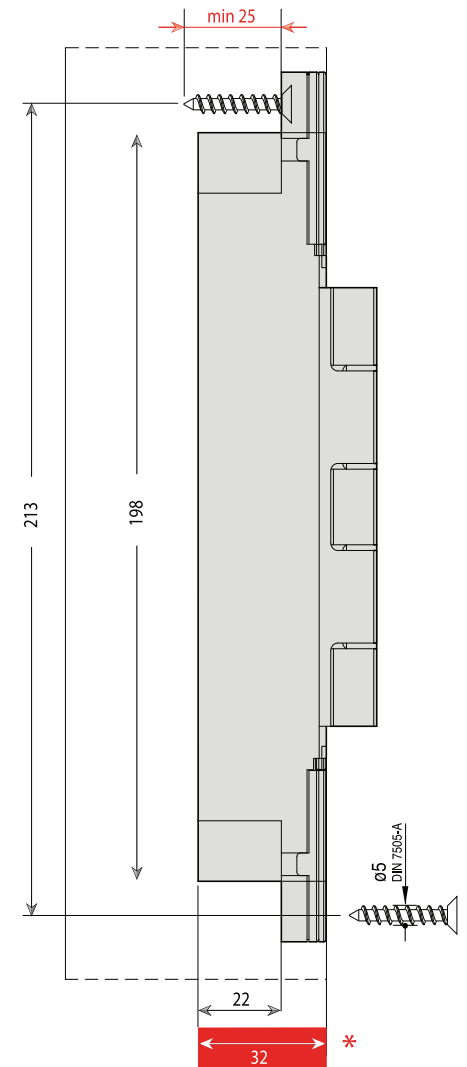
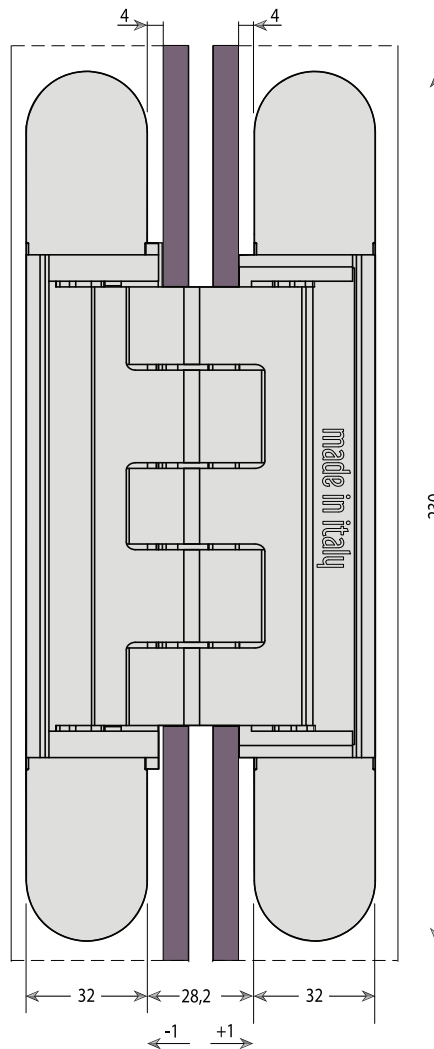

* Small drilling depth

HINGE

บานพับ

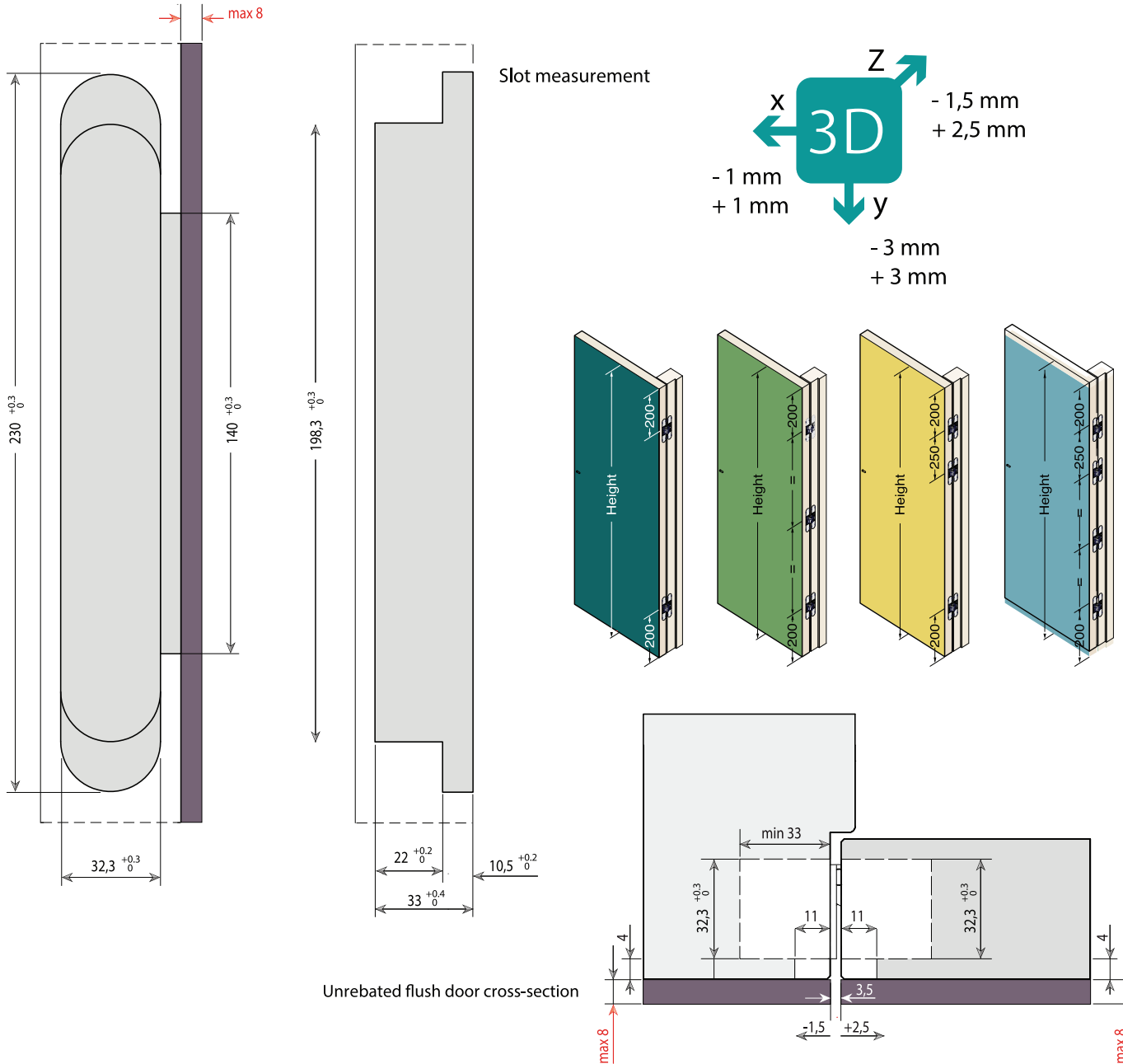

2 HINGES LOAD CAPACITY CHART

DOOR HEIGHT (mm)	2200	160	160	160	157	133	119	108
	2100	160	160	160	144	125	112	103
	2000	160	160	160	133	117	107	99
	1900	160	160	145	124	111	102	95
		700	800	900	1000	1100	1200	1300
		DOOR WIDTH (mm)						

3 HINGES LOAD CAPACITY CHART

DOOR HEIGHT (mm)	3000	195	195	195	195	195	195	195	4 HINGES SUGGESTED
	2900	195	195	195	195	195	195	195	
	2800	195	195	195	195	195	195	183	
	2700	195	195	195	195	195	195	170	
	2600	195	195	195	195	195	185	160	
	2500	195	195	195	195	195	171	150	
	2400	195	195	195	195	187	160	142	
	2300	195	195	195	195	172	149	134	
	2200	195	195	195	191	160	140	127	
	2100	195	195	195	174	149	132	121	
	2000	195	195	195	160	139	125	116	
		700	800	900	1000	1100	1200	1300	
		DOOR WIDTH (mm)							

For special door sizes and use of door closer devices, please see the technical guidelines

HINGE

บานพับ



Adjustment guidelines H1432W | H929

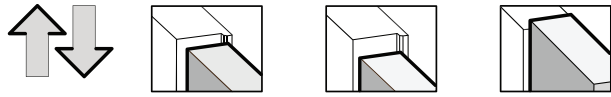

Vertical adjustment

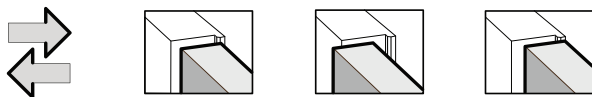
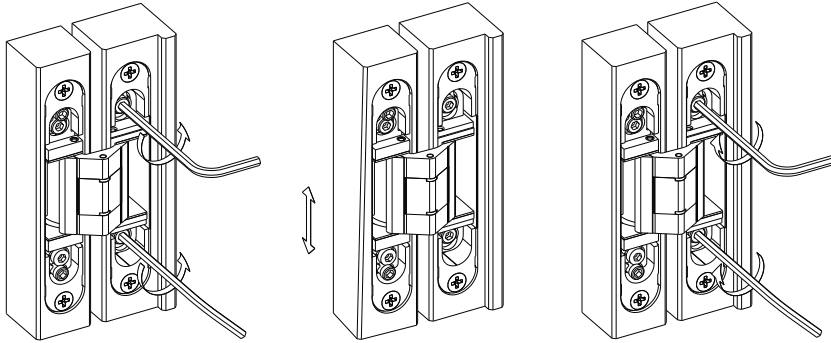
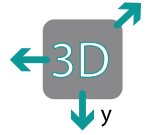

Horizontal adjustment

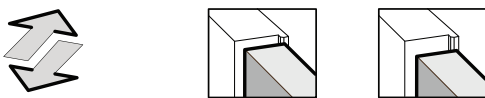
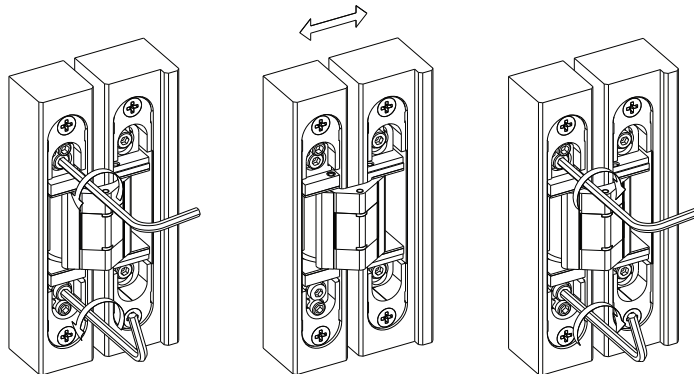
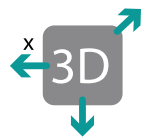

Depth adjustment

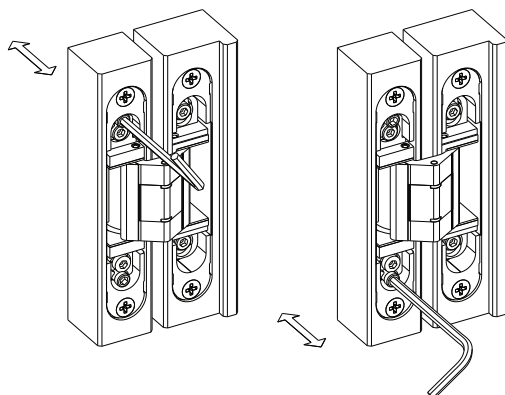
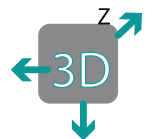

3D ADJUSTABLE CONCEALED DOOR HINGES - MODEL H1131



S.T.A.R.S. H1131

THE CEAM HINGE FOR HEAVY DUTY DOORS

3D concealed hinges: guaranteed by strict durability tests and tested for fire doors up to 120 minutes, 1131s is even more versatile due to the wide gap between its wings.

Height: 160 mm

Depth: 29 mm

Minimum door thickness: 38 mm

Utilization: Residential, Commercial, Office, Entrance door, Marine use

Width: 32 mm

Suitable for doors: Wood, Aluminium, Steel

Fire resistance: EI30, EI60, EI120



Load capacity 2 hinges: 80 kg

Load capacity 3 hinges: 120 kg

For special door sizes and use of door closer devices, please read carefully the technical guidelines.

HINGE

บานพับ



H1131
mm.160x32

Invisible adjustable hinges for doors

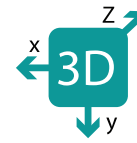

Available in 11 finishes.

MAIN FEATURES:

- Manufactured in zamak in 11 different finishes
- Suitable for doors of 38 mm min. thickness
- Total length 160 mm
- Depth 29 mm
- 3D adjusting system S.T.A.R.S.
- Load capacity up to 120 kg
- Easy installation and slot symmetry
- Revised in aesthetics and operation: now more elegant and resistant to oxidation due to the new external case in zincked zamak. Joint evolved for better performance: smoother movement, extremely precise, durable and now certified for doors up to 1000 mm wide



MAINTENANCE**FREE**

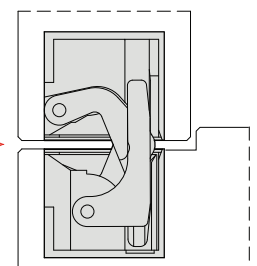
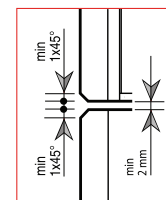
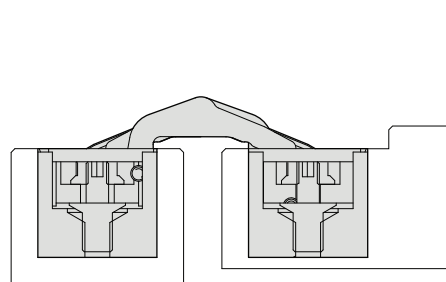
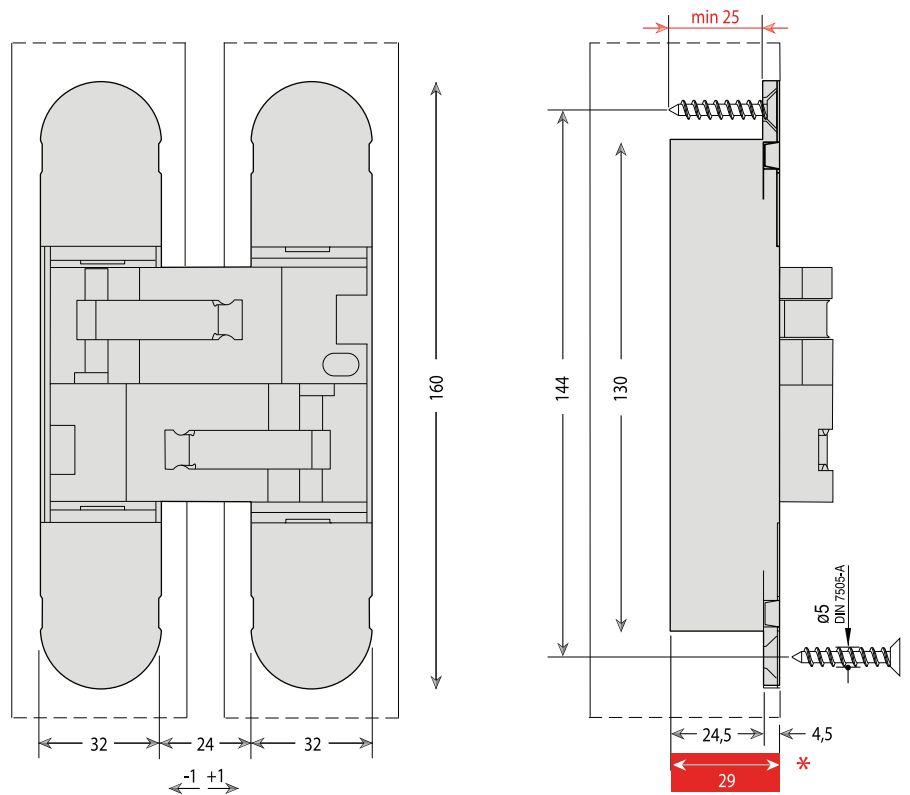
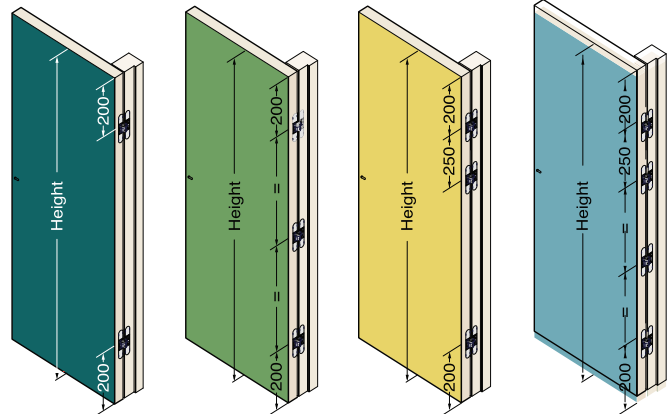

* Small drilling depth

HINGE

บานพับ

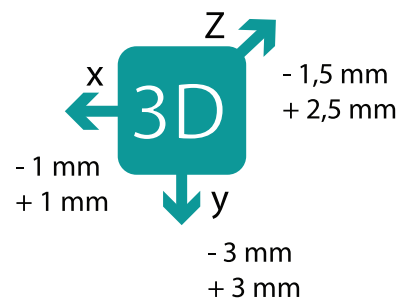
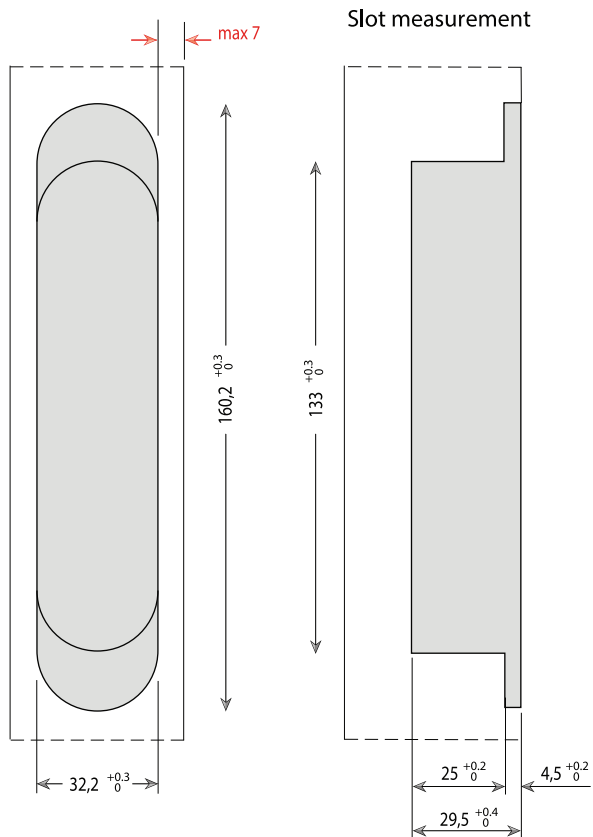

REVERSIBILITY
Reversible for doors from 38 mm to 46 mm thick

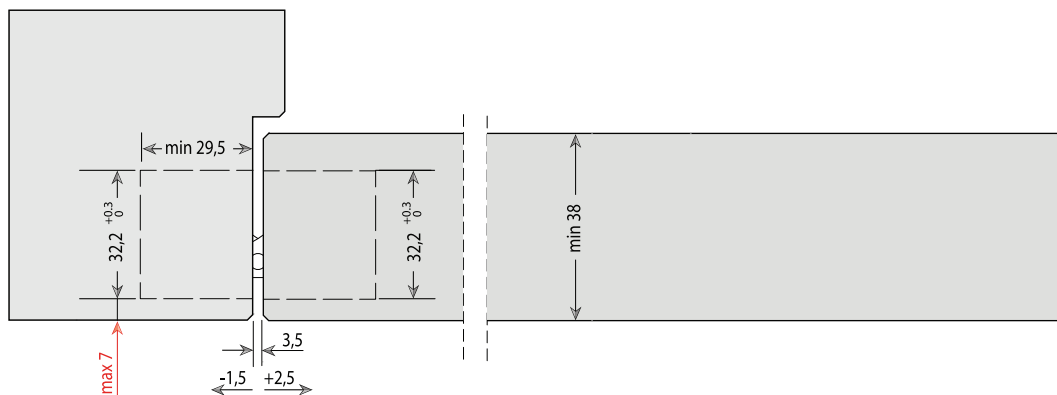
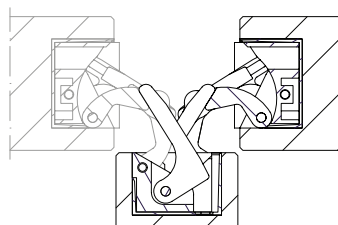

2 HINGES LOAD CAPACITY CHART

DOOR HEIGHT (mm)	2200	80	80	80	78	66	59	54
	2100	80	80	80	72	62	56	52
	2000	80	80	80	66	58	53	49
	1900	80	80	73	62	55	51	47
		700	800	900	1000	1100	1200	1300
	DOOR WIDTH (mm)							

3 HINGES LOAD CAPACITY CHART

DOOR HEIGHT (mm)	3000	120	120	120	120	120	120	120	4 HINGES SUGGESTED
	2900	120	120	120	120	120	120	120	
	2800	120	120	120	120	120	120	112	
	2700	120	120	120	120	120	120	105	
	2600	120	120	120	120	120	114	98	
	2500	120	120	120	120	120	105	92	
	2400	120	120	120	120	115	98	87	
	2300	120	120	120	120	106	92	83	
	2200	120	120	120	117	98	86	78	
	2100	120	120	120	107	91	82	75	
	2000	120	120	120	98	85	77	71	
		700	800	900	1000	1100	1200	1300	
		DOOR WIDTH (mm)							

For special door sizes and use of door closer devices, please see the technical guidelines

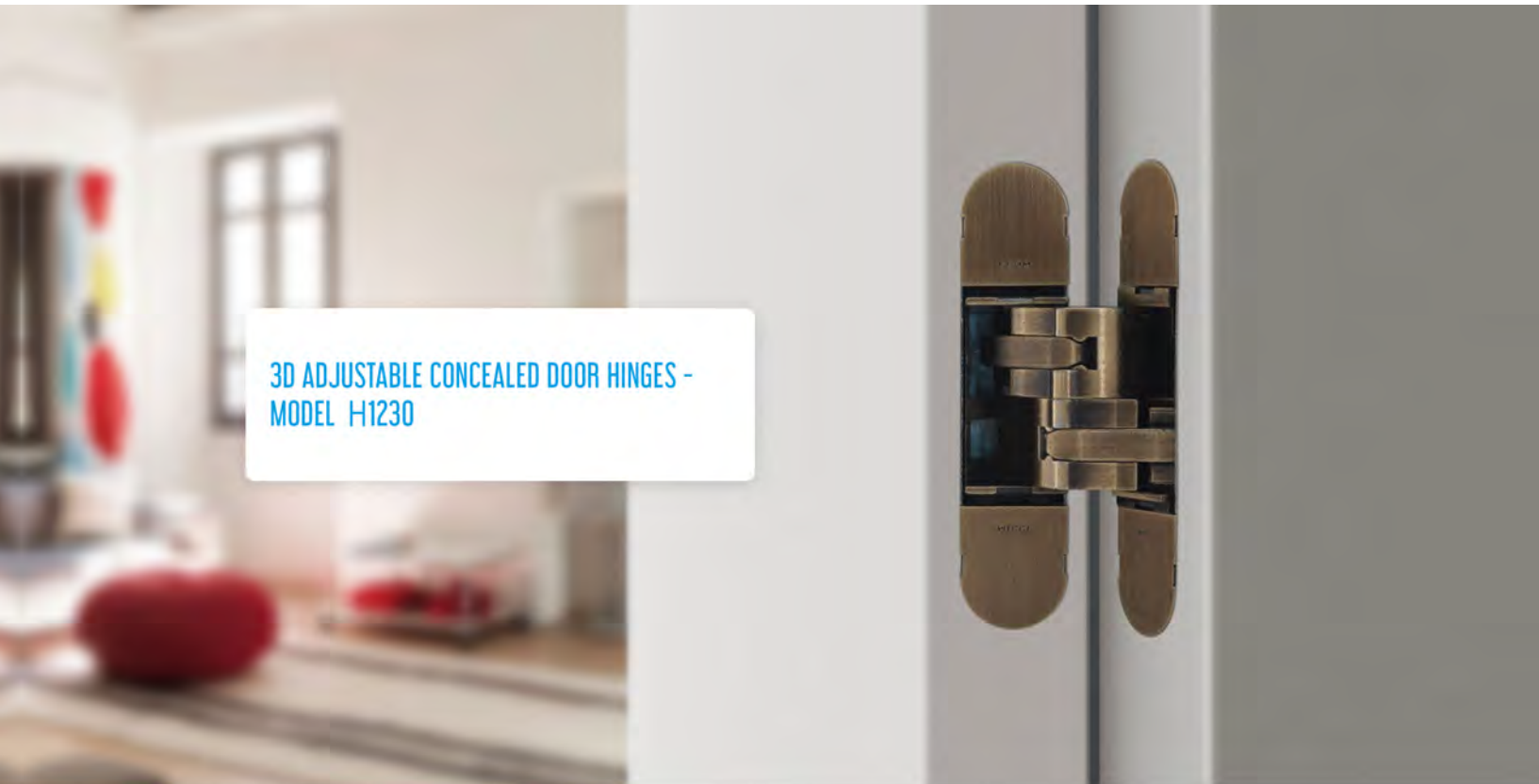

3D ADJUSTABLE CONCEALED DOOR HINGES -
MODEL H1230

S.T.A.R.S. H1230

THE REVERSIBLE HINGE FOR DOORS WITH THICKNESS FROM 35 TO 45MM

3D concealed hinges: with a gap between the two wings of 23mm, 1230s is the ideal solution for reversible doors or to go around skirting boards or trims or claddings.



Height: 130 mm

Depth: 21 mm

Minimum door thickness: 35 mm

Utilization: Residential, Commercial, Office

Width: 30 mm

Suitable for doors: Wood, Aluminium, Steel

Fire resistance: EI30



Load capacity 2 hinges: 55 kg

Load capacity 3 hinges: 70 kg

For special door sizes and use of door closer devices, please read carefully the technical guidelines.

HINGE

บานพับ



H1230
mm.130x30

Invisible adjustable hinges for doors

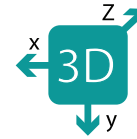

Available in 11 finishes

MAINTENANCE**FREE**

MAIN FEATURES:

- Manufactured in zamak in 11 different finishes
- Suitable for doors of 35 mm min. thickness
- Big reversibility range: central for doors from 35 to 45 mm thick
- Suitable in case of baseboard or claddings till 15,5 mm
- Total length 130 mm
- Depth 21 mm only
- 3D adjusting system S.T.A.R.S.
- Load capacity up to 70 kg
- Easy installation and slot symmetry
- Revised in aesthetics and operation: now more elegant and resistant to oxidation due to the new external case in zincked zamak. Joint evolved for better performance: smoother movement, extremely precise, durable and now certified for doors up to 1000 mm wide

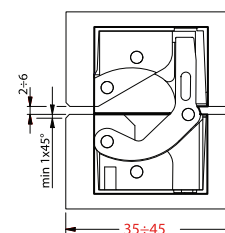
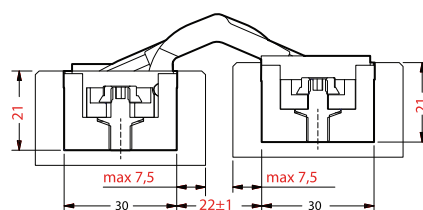
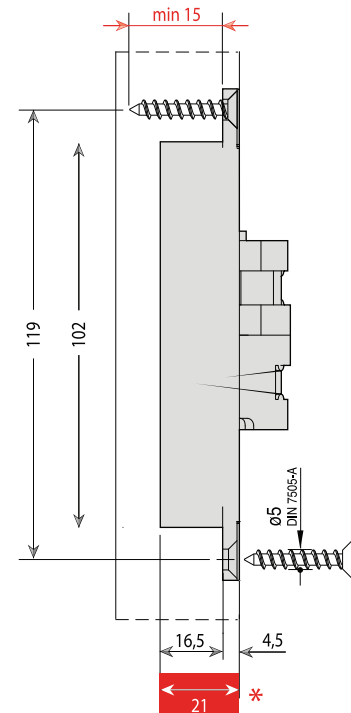
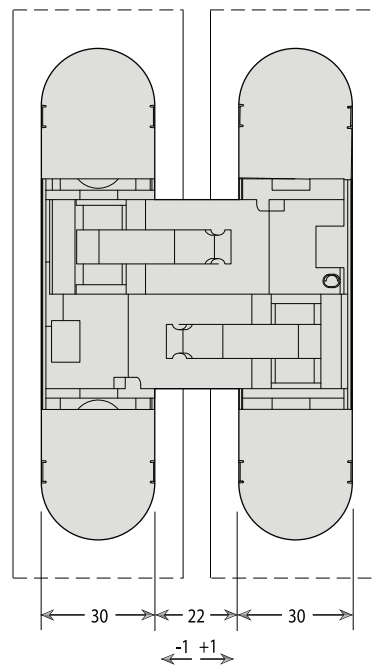
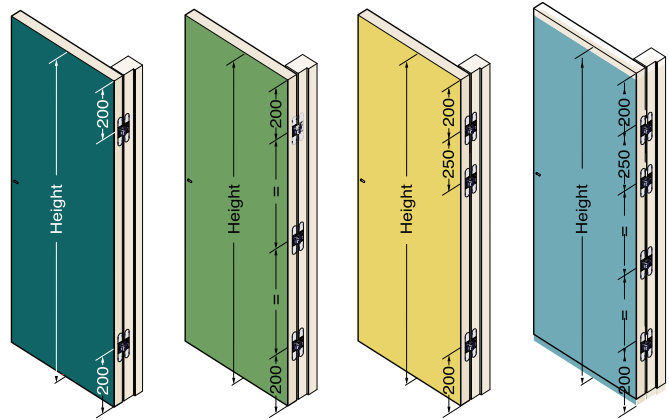

* Small drilling depth

HINGE

บานพับ

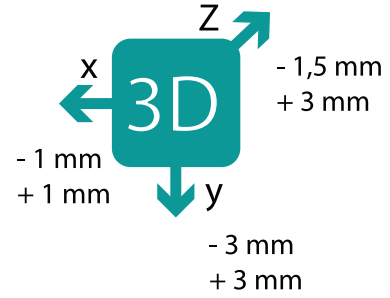
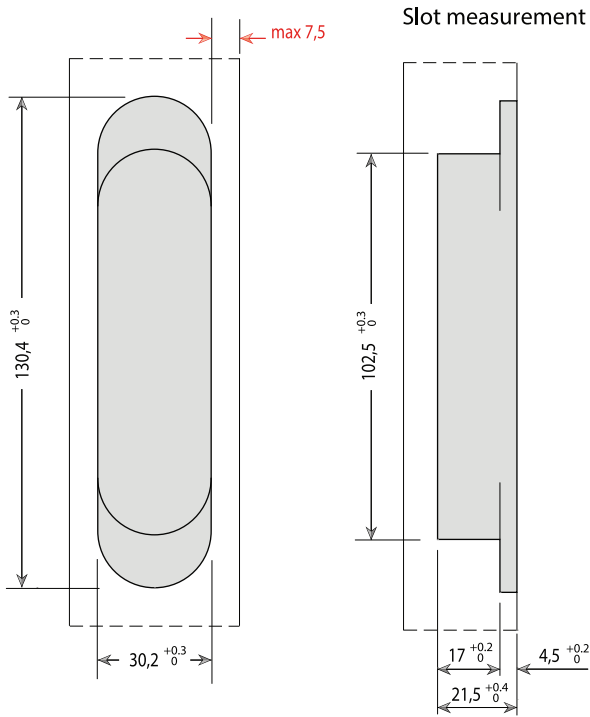

REVERSIBILITY

Reversible for doors from 35 mm to 45 mm thick

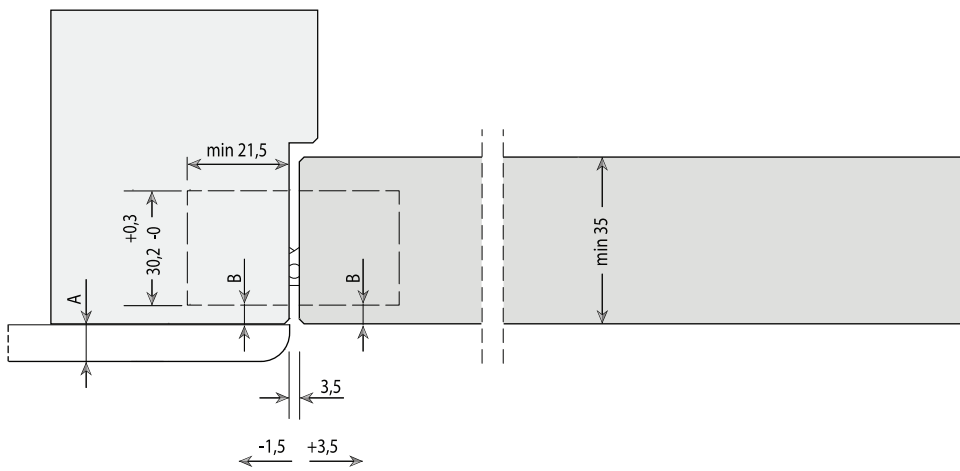
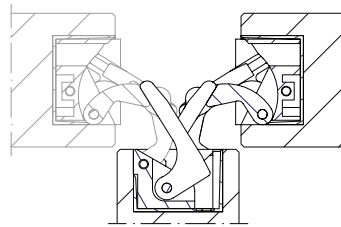

Door cross-section

A	B
15,5	2,5
14,5	3
13,5	3,5
12	4
10	4,5
8	5

DOOR HEIGHT (mm)	2 HINGES LOAD CAPACITY CHART						
	700	800	900	1000	1100	1200	1300
2200	55	55	55	54	46	41	37
2100	55	55	55	50	43	39	36
2000	55	55	55	46	41	37	34
1900	55	55	50	43	38	35	33

DOOR HEIGHT (mm)	3 HINGES LOAD CAPACITY CHART							4 HINGES SUGGESTED
	700	800	900	1000	1100	1200	1300	
3000	70	70	70	70	70	70	70	4 HINGES SUGGESTED
2900	70	70	70	70	70	70	70	
2800	70	70	70	70	70	70	65	
2700	70	70	70	70	70	70	61	
2600	70	70	70	70	70	66	57	
2500	70	70	70	70	70	61	54	
2400	70	70	70	70	67	57	51	
2300	70	70	70	70	62	54	48	
2200	70	70	70	68	57	50	46	
2100	70	70	70	62	53	47	44	
2000	70	70	70	57	50	45	42	

For special door sizes and use of door closer devices, please see the technical guidelines

HINGE

บานพับ



Adjustment guidelines H1131 | H1230

Invisible adjustable hinges for doors

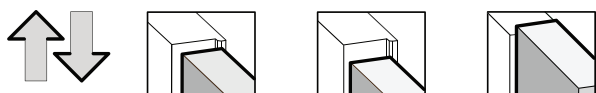

Vertical adjustment

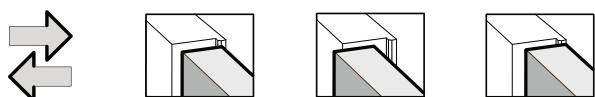
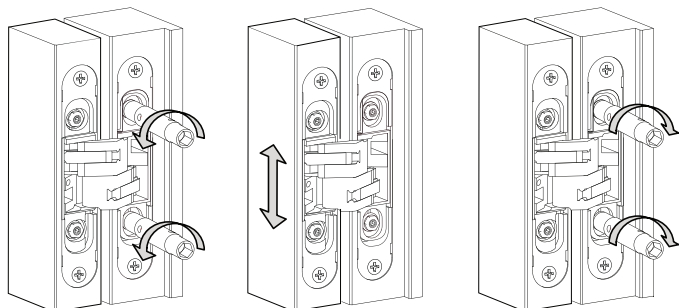
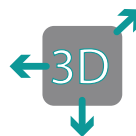

Horizontal adjustment

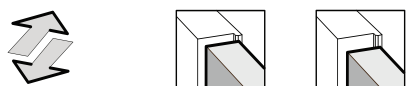
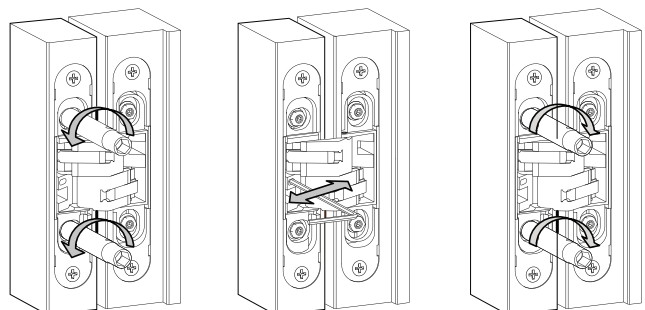
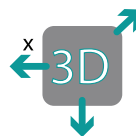

Depth adjustment

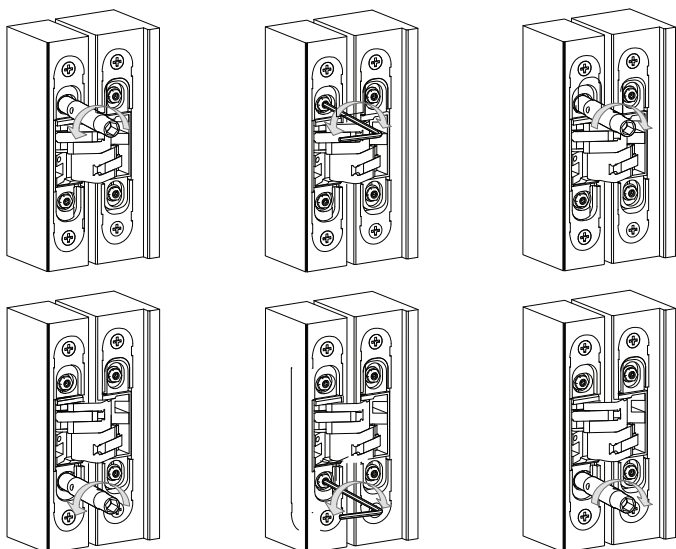
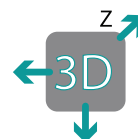

3D ADJUSTABLE CONCEALED DOOR HINGES - MODEL H929



SMALL FUNCTIONAL AND ELEGANT H929

It hides in your cabinet creating magnificent design, here is the first adjustable 3D hinge by Ceam dedicated to the world of furniture.

Height: 76 mm

Depth: 15 mm

Minimum door thickness: 18 mm

Utilization: Residential

Width: 14 mm

Suitable for doors: Wood, Aluminium, Steel

Fire resistance: n.d.



Load capacity 2 hinges: 14 kg

Load capacity 3 hinges: 18 kg

For special door sizes and use of door closer devices, please read carefully the technical guidelines.

HINGE

บานพับ



H929

mm.76x14

Invisible adjustable hinges for doors and cabinet

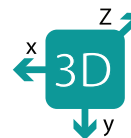

Available in 6 finishes.

MAINTENANCE**FREE**

MAIN FEATURES:

- Now available in White painted
- The first Ceam 3D hinge for cabinet, adjustable with one simple tool
- Manufactured in zamak and fibreglass in 6 different finishes
- Suitable for doors of 18 mm min. thickness
- Mini-invasive: only 15 mm deep
- The strongest on its segment: load capacity up to 16 kg tested on doors 1200x600 mm

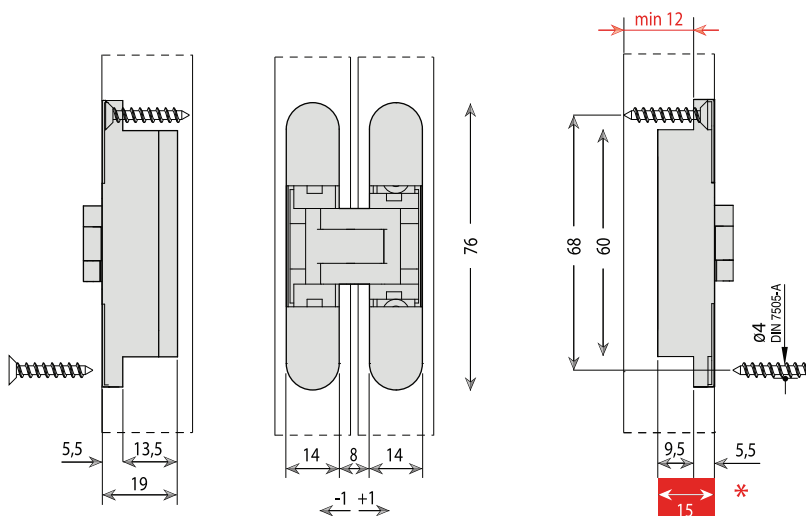
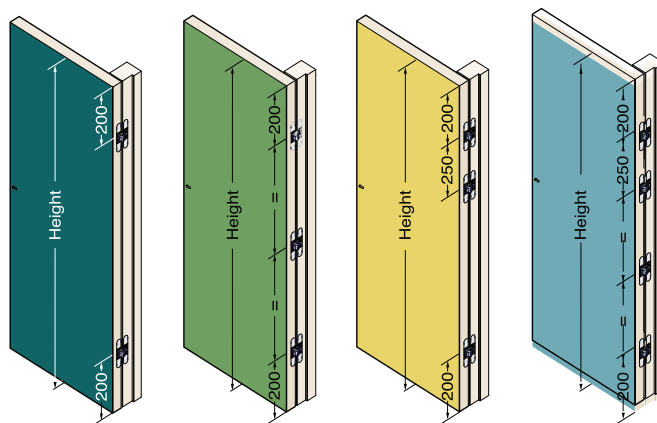

* Small drilling depth

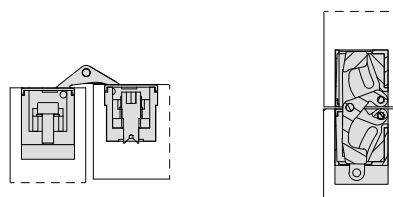

HINGE

บานพับ

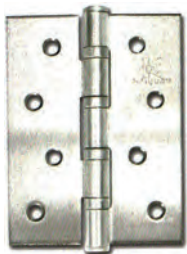

H - 164SS(2 mm)4BB

บานพับสแตนเลสแหวนลูกปืนหัวตัด
ขนาด 4" x 3" x 2 mm

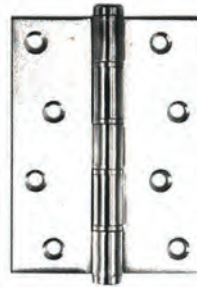

H - 164(2 mm)4W

บานพับแกนสแตนเลสหัวตัด
ขนาด 4" x 3" x 2 mm 4แหวน

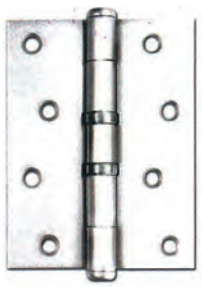

H - 164SS

บานพับสแตนเลสแหวนลูกปืนหัวตัด
ขนาด 4" x 3" x 2 mm
4" x 3" x 2.5 mm
4" x 3" x 3 mm
4" x 4" x 2.5 mm
5" x 3.5" x 3 mm
5" x 4" x 3 mm
6" x 4" x 3 mm



H - 164G

บานพับทองเหลืองหัวตัด
ขนาด 4" x 3" x 2.5 mm
4" x 4" x 3 mm
5" x 4" x 3 mm



H - 164/1G

บานพับทองเหลืองหัวจุก
ขนาด 4" x 3" x 2.5 mm
4" x 4" x 3 mm
5" x 4" x 3 mm



H - 204

บานพับสปริง สแตนเลสสองหน้า
ขนาด 3", 4", 5"



H - 204/1

บานพับสปริง สแตนเลสหน้าเดียว
ขนาด 3", 4"

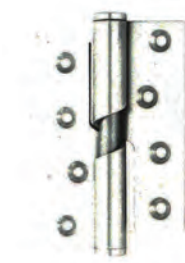

H - 365

บานพับสแตนเลสปิดอัตโนมัติ
ไม่มีแหวนหัวตัด
ขนาด 4" x 3" x 2.5 mm

HINGE

บานพับ

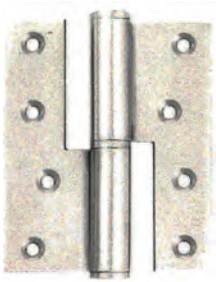

H - 285/2

บานพับถอดสแตนเลส
ด้านซ้ายและด้านขวา
ขนาด 4" x 3.5" x 3 mm

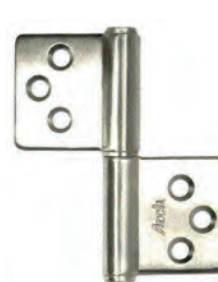

H - 285/3

บานพับถอดสแตนเลส
ขนาด
76.2 x 30 x 2.5 mm
127 x 50 x 3 mm



H - 285

บานพับถอดสแตนเลส
ด้านซ้ายและด้านขวา
ขนาด 100 x 55 x 2 mm

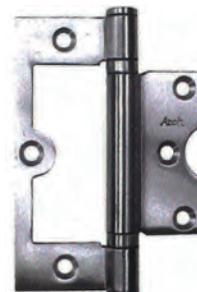

H - 208

บานพับบานเพ็ยมสแตนเลส
แหวนลูกปืน
ขนาด 100 x 70 x 25 mm

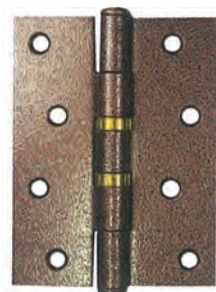

H - 164AB

บานพับเหล็กพ่นลาย
แหวนทองเหลืองหัวตัด
ขนาด 4" x 3" x 2 mm
สีทองแดงรมดำ

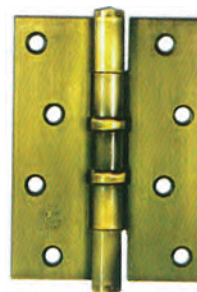

H - 164/2G

บานพับเหล็กรมดำแหวนลูกปืนหัวตัด
ขนาด 4" x 3" x 2 mm
4" x 4" x 2 mm
5" x 4" x 2 mm
สีทองเหลืองรมดำ, ทองแดงรมดำ



H - 141

บานพับซ่อน
Concealed Hinge
ขนาด 45 mm
60 mm
70 mm
95 mm
118 mm



H - 208 G

บานพับบานเพ็ยมทองเหลือง
ขนาด 3"
สีเงินดำ, ทองเงา

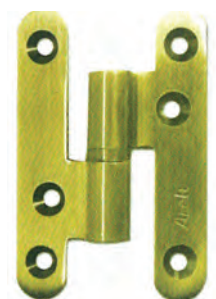

H - 285/5

บานพับถอดทองเหลือง
ด้านซ้ายและ ด้านขวา
ขนาด 64 x 40 x 2.5 mm
76 x 51 x 2.5 mm
100 x 55 x 2.5 mm
สีทองเหลืองรมดำ, ทองแดงรมดำ,
ทองเงา



H - 297

บานพับถอดสแตนเลส
ขนาด 3" x 3" x 3 mm
4" x 4" x 3 mm
5" x 4" x 3 mm
สีทองเหลืองรมดำ, ทองแดงรมดำ

HINGE

บานพับ

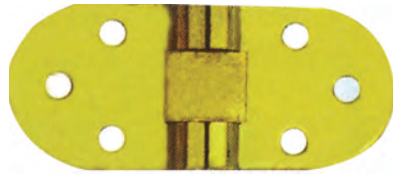

H - 300 ซิ้งค์ บานพับจักรซิ้งค์อะลอย

H - 300 ทองเหลือง บานพับจักรทองเหลือง

ขนาด 30 x 82 x 2 mm ขนาดแกน 6.5 mm



H - 371G บานพับทองเหลืองหูช้าง

ขนาด 3" x 5" x 4 mm

4" x 4" x 4 mm

4" x 6" x 4 mm

4" x 8" x 4 mm



H - 300AB

บานพับจักรเหล็กกรมดำ

ขนาด 30 x 82 x 2 mm

ขนาดแกน 5.5 mm

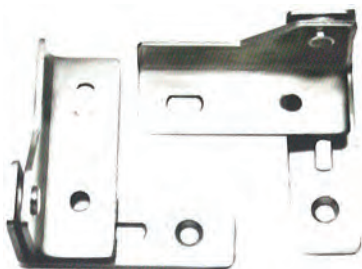

H - 358

บานพับช่องซาร์ฟสแตนเลส

ขนาด 3" x 3"

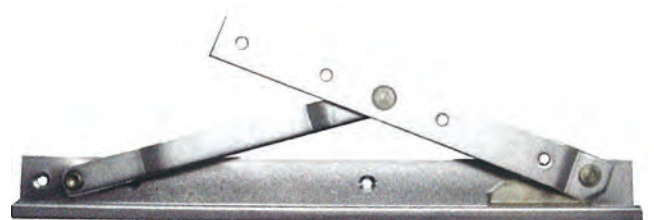

H - 361

บานพับบานหน้าต่างสแตนเลส

ขนาด 10", 12", 14", 16"



H - 360

บานพับซ่อนยาวสแตนเลส

ขนาด 3/4" x 4 1/2" x 4 mm

1" x 5" x 4 mm



H - 359

บานพับยาวสแตนเลส

ขนาด 3/4" x 1.20 m x 0.7 mm

1 1/4" x 1.20 m x 1.5 mm

3/4" x 3.50 m x 1 mm

สีสแตนเลส, สีโครเมียม, ทองเงา